

0 603 337 903

Stand } 01-05-08 **Fig./Abb. 1**
Issue }

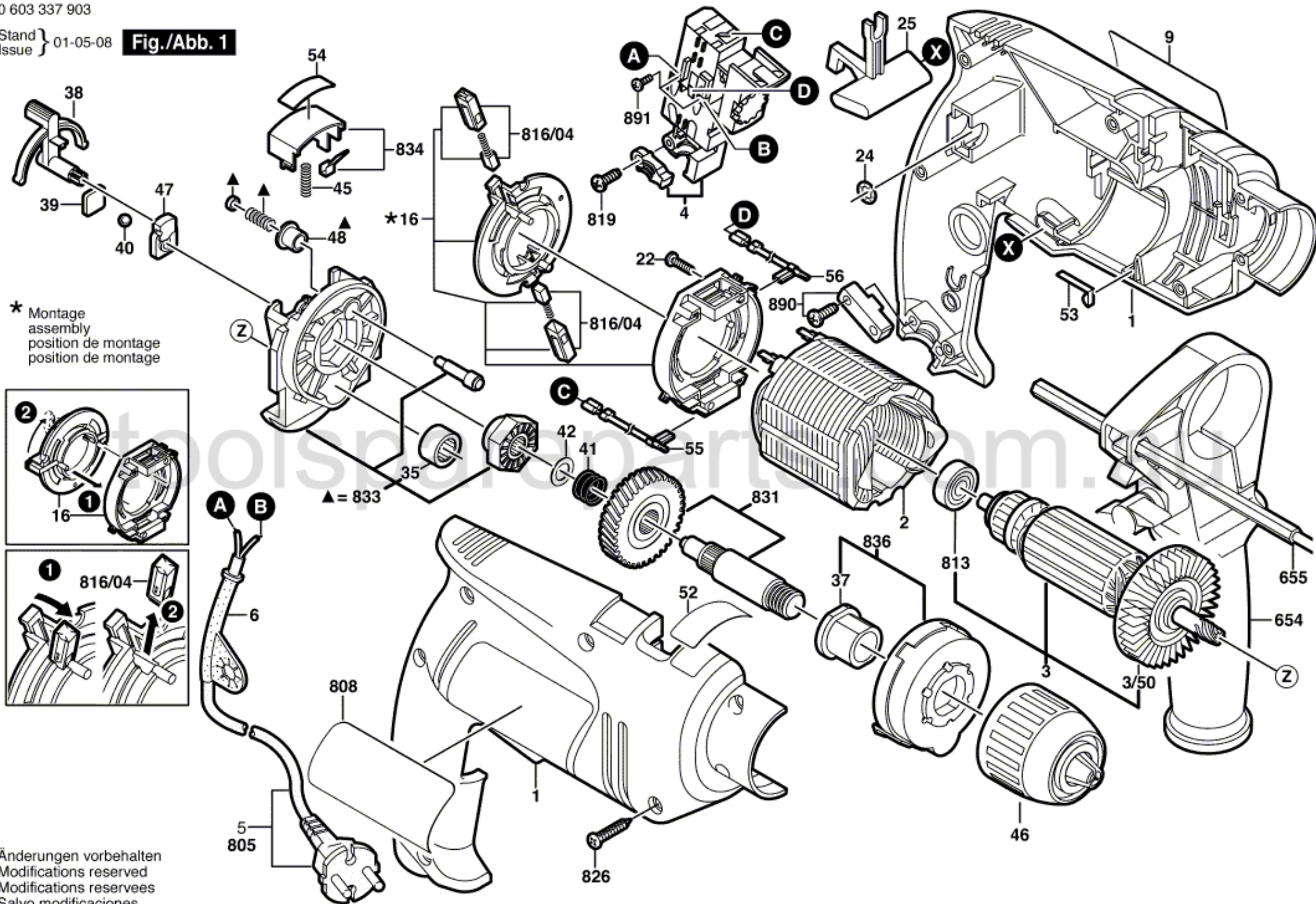

Änderungen vorbehalten
Modifications reserved
Modifications reserves
Salvo modificaciones